



PRODUCT INFORMATION & INSTALLATION GUIDE 2022

Airius Model EC
ONYX SERIES

www.airius.co.uk

AIRIUS[®]
saving you energy

MODEL EC DIMENSIONS AND PROPERTIES



UNIT SIZE

Weight:	6 kgs (13 lbs)
Height to Rim:	307 mm (12.1 in)
Total Height:	424 mm (16.7 in)
Diameter:	391 mm (15.4 in)

STANDARD

MOTOR

Watts*:	87
RPM*:	1690
L/S*:	637
m ³ /hr:	2294 (1350 CFM)
Centre Line Velocity ¹ :	1.90 m/s @ 9 m
AMPS*:	0.36

230V @ 50 Hz

*Motor data provided by motor manufacturer and is subject to change at anytime
¹Velocity profile tested in situ

COVERAGE

Ceiling Height	= Up to 15m (49ft)
Nozzle Height	= Up to 14m (46ft)
Floor area	= Up to 182m ² (1959ft ²)

All data is indicative only and can change subject to application. For more accurate design please contact Airius.

MOTOR

Single Phase
Electrically commutated, variable speed 92% efficient motor
German EBM Papst EC motor
230 Volt @ 50/60 Hz

OPERATING TEMPERATURES

Min start temp (approx.)	= - 10° C
Min running temp	= - 25° C
Shut off	= 110° C
Reset	= 90° C

HOUSING

PC/ABS Resin - Inc. internal fixed blade stator
5VA flame resistance rating

INGRESS PROTECTION

IP54 Rated

NOISE LEVELS

Sound Pressure Level @ 15 mts = 42 dB(A)

Note: A typical free field environment over a reflecting plane.
All acoustic testing conducted at 230 Volt, 50Hz and undertaken at the EBM- Papst Acoustic Laboratories in Connecticut USA during August 2014

Please contact Airius for full Noise Testing Report

COLOUR

Off white only available ex factory

If black or another colour required, an extra cost will be charged for spray painting the fan.

ACCESSORIES & OPTIONS

Multiple speed control options available:
- Full 0-100% potentiometer speed control option
- Fully programmable Airius touch screen controller
- Airius PearLink WiFi Control

Fully BMS controllable

Bacnet Protocol for individual fan control

For horizontal installations Airius recommend the use of the Airius proprietary cradle or a second cable or rod attachment to the discharge end to provide balance

WARRANTY

5 years parts and workmanship from shipping date
120 day money back guarantee (T's & C's apply)

VELOCITY PROFILE

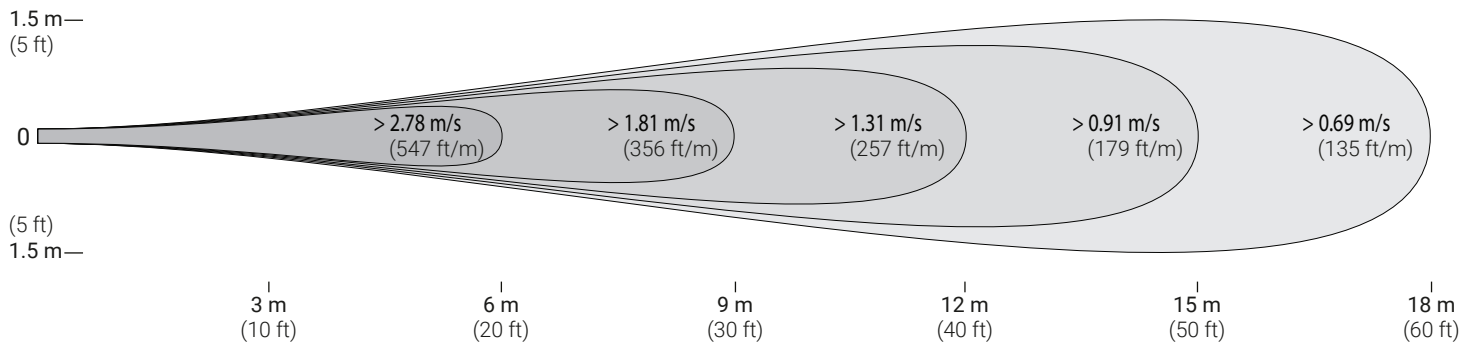

UNIT PLACEMENT

PREPARATION

Install electrical circuit(s) and outlet(s) in accordance with national and local electric codes.

Outlets should generally be mounted vertically unless a “twist/locking” type is being used.

Wall switch may be installed in circuit to disable power and prevent electrical hazards when servicing.

Confirm electrical continuity of Airius unit on the ground before permanently mounting in the ceiling.

MAINTENANCE

Frequency of cleaning will vary by application and environment.

You may clean the plastic housing with a damp warm cloth, using mild household detergents.

Do not use petroleum products, thinners or solvents to clean any part of the Airius unit.

If the Airius unit fails, contact manufacturer.

MATERIALS & PROPERTIES

Constructed from recyclable materials.

The outer shell, stator and fan blades are fire rated 5VA materials.

Power cord is a 1.8m, 3 wire, 1.02 mm diameter 300VAC rated electrical cord - CE/EU compliance rated as HO5VV (PLUG NOT SUPPLIED).

Electrically commutated, variable speed 92% efficient motor.

Motor is thermally protected. Shutoff is at 110°C & reset is at 90°C.

No lubrication required. Bearings are sealed.

OPERATION

Designed to operate 24 hours-a-day, 7 days-a-week to maintain air circulation/thermal equalization/humidity equalization.

Use optional speed control to fine tune RPM if needed.

INSTALLATION

Do not hard connect fans in excess of 10 kgs unless agreed with Airius prior to Installation. When attaching it is preferred if some chain or cable is used between fan and the support. However it is not imperative.

For Cooling the Airius fan should be located to suit client's requirements. Suggested locations are from just under the ceiling or closer to the floor to ensure suitable air-cooling flow.

For Heating or Conditioned Spaces the Airius fan should be securely installed as close as possible to the ceiling.

For combination applications fans can be installed close to ceiling or lowered slightly. Contact Airius for design details and assistance.

The Airius unit performs best when air column from the nozzle is unimpeded to the floor.

The Airius unit should not be mounted directly in front of heat ducts, vents or any other high heat source.

Use professionally installed hardware, capable of supporting a minimum of five times the weight of the fan unit.

Hardware to hang the unit includes but is not restricted to: Hooks, chains, cables, carabiners, bridle rings, beam clamps and bolts.

Density of the placement is directly related to the effectiveness, performance and savings.

Mount out of reach from people and animals.

Floor plans, mezzanines, office locations, machinery, people placement, plumbing, lighting, duct work, electrical systems, natural light/air systems, cranes, doors, windows, ventilation and fire suppression systems are all factors in properly locating the Airius system within the ceiling.

CHAIN HUNG (STRAIGHT)

PLUG NOT SUPPLIED

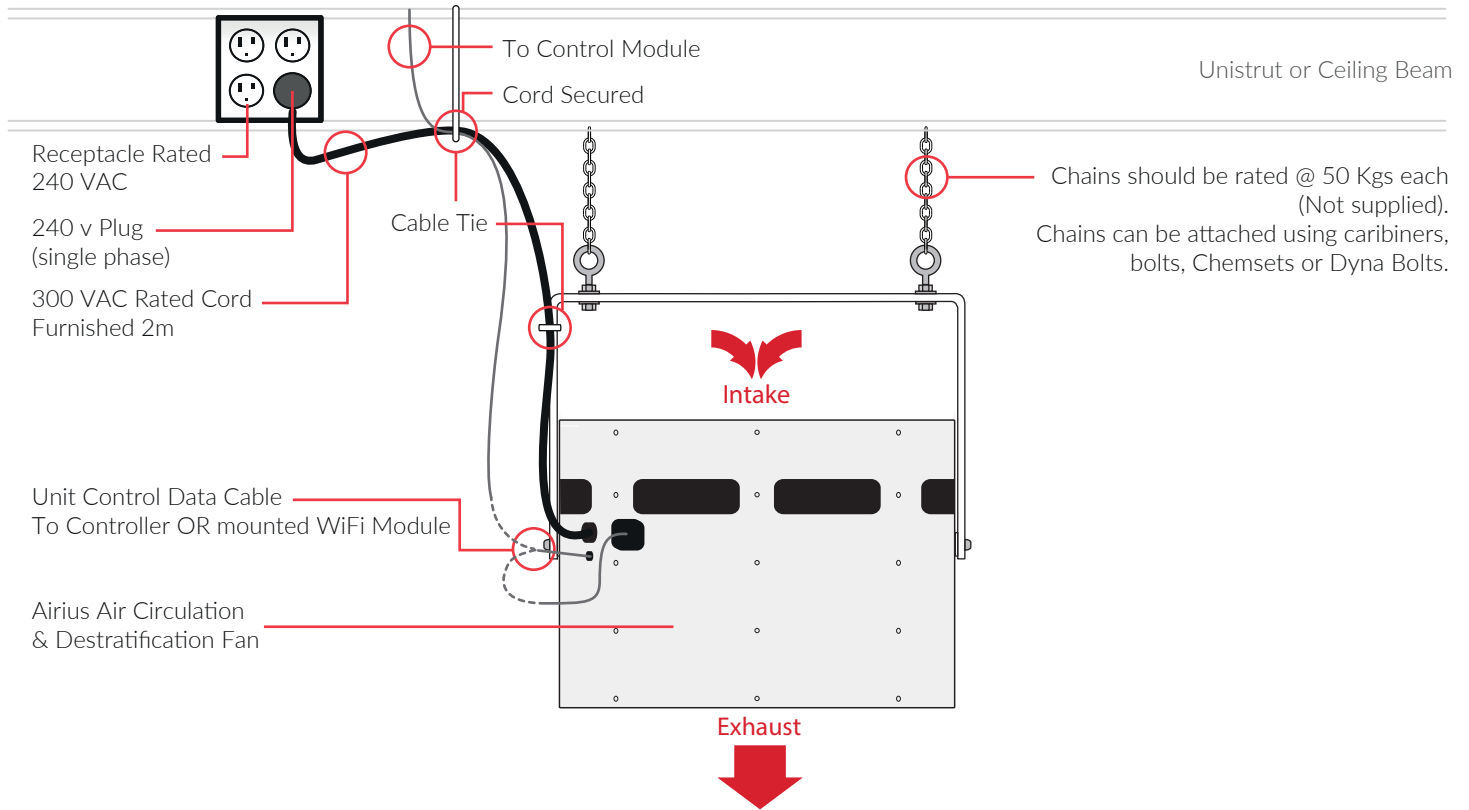

CEILING FIXED (STRAIGHT)

PLUG NOT SUPPLIED

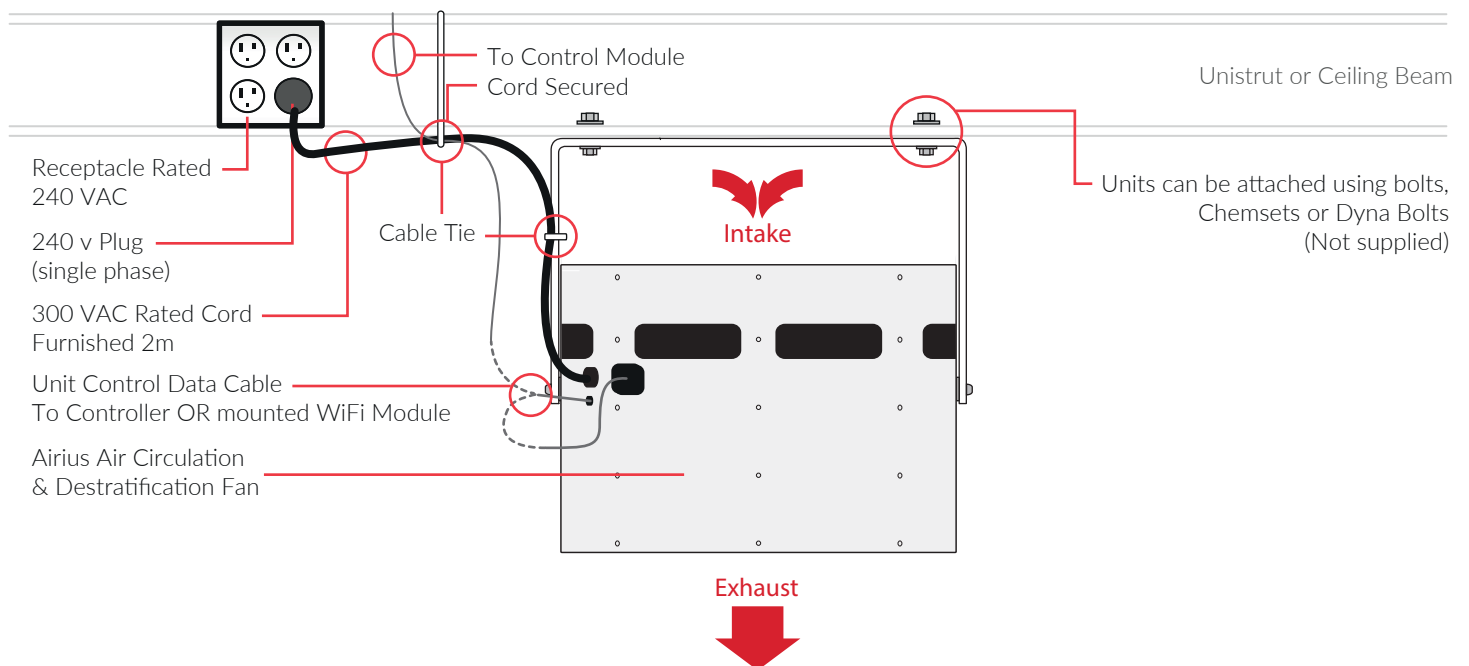

CHAIN HUNG (ANGLED)

PLUG NOT SUPPLIED

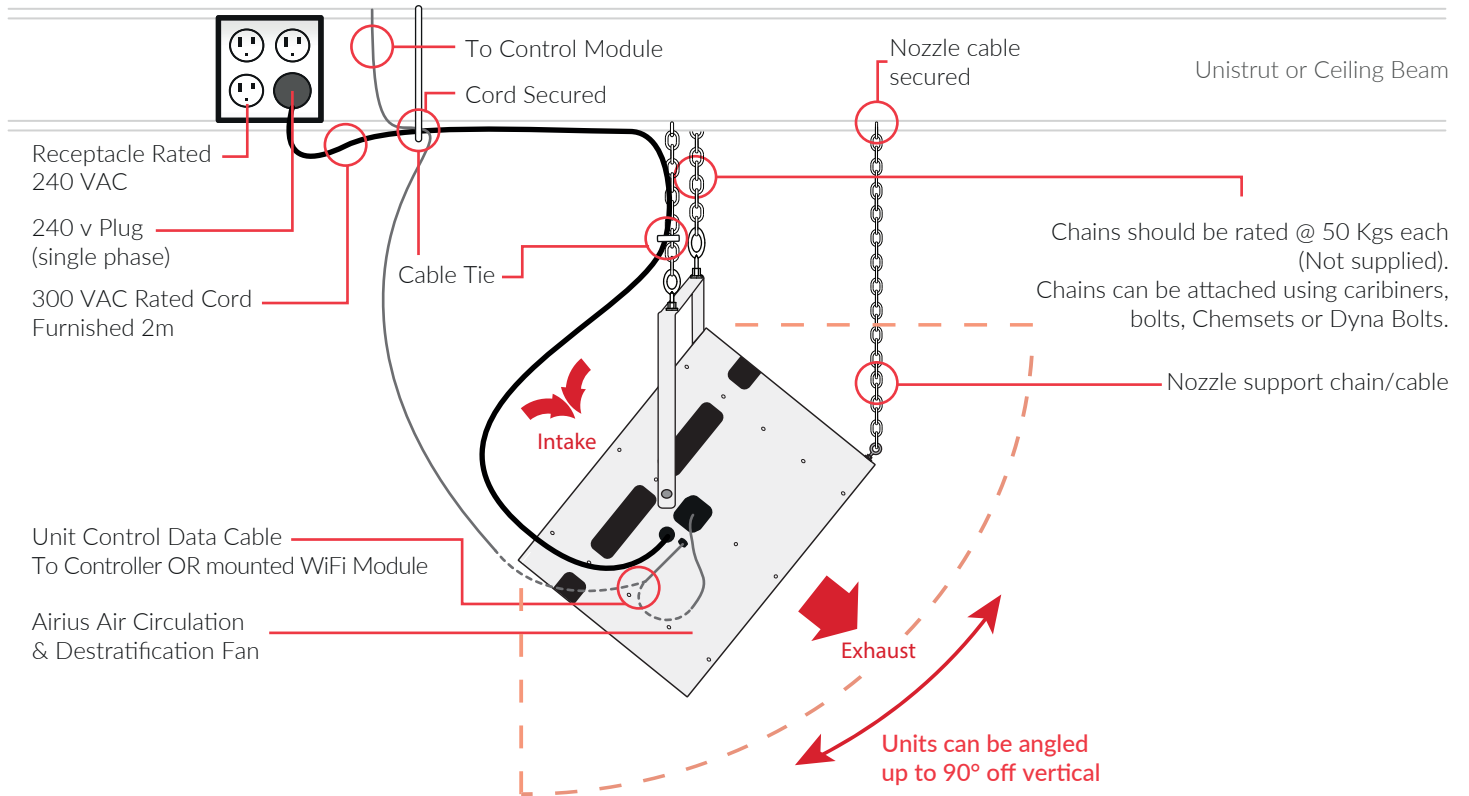

CEILING HUNG (ANGLED)

PLUG NOT SUPPLIED

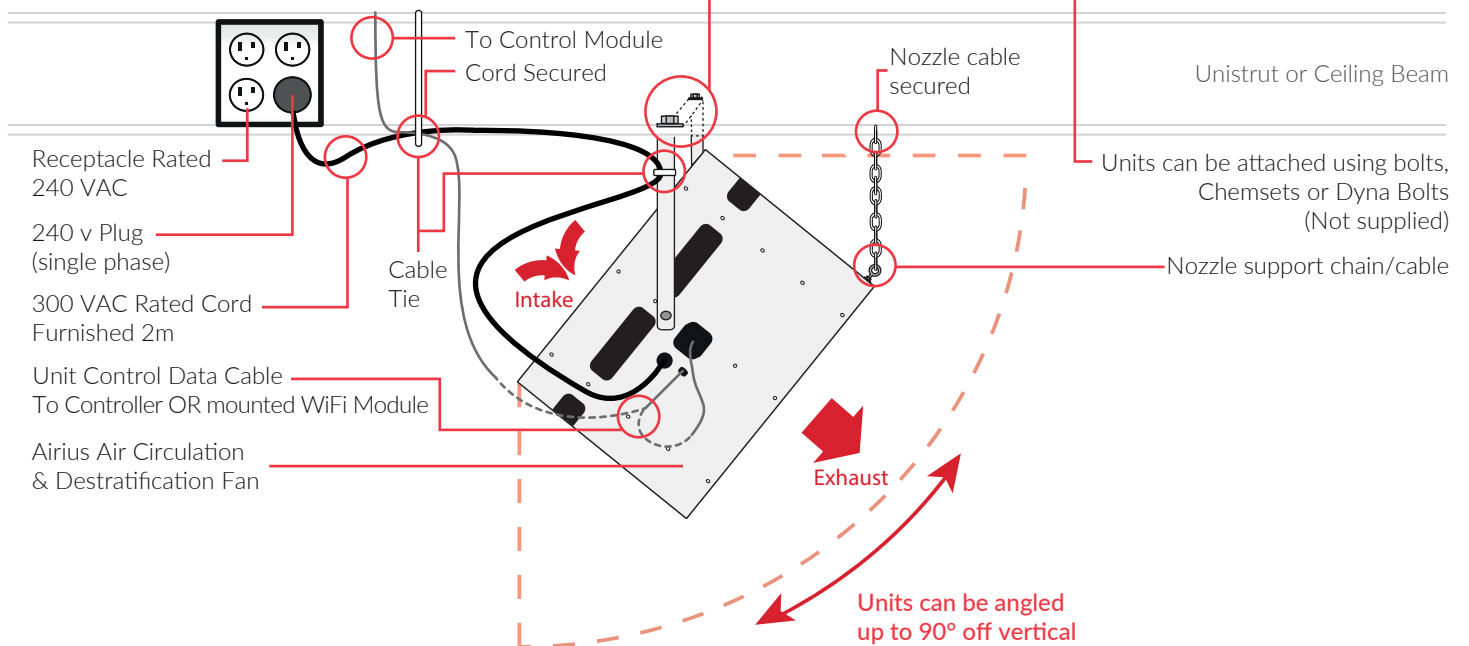

PEARLINK

Reduce installation cost & control your Airius fan system over 2.4Ghz WiFi

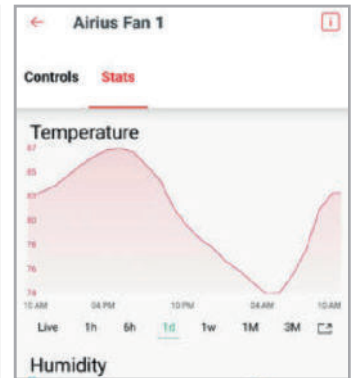
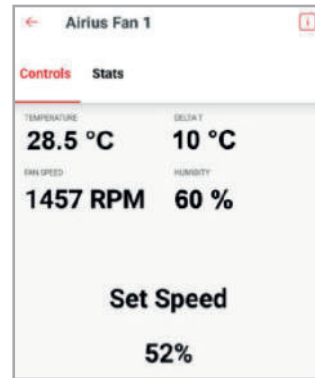

DISTRIBUTED COMFORT

The PearLink control system offers total fan control from a desktop or mobile device. It integrates with existing Wi-Fi to provide wireless connectivity for monitoring air temperatures and stratification levels for cooling and heating applications and to provide individual or grouped fan control. This factory installed option will replace all control wiring and manual wall controls. Each installation can, at a small cost, include a floor sensor to be installed near your thermostat to monitor room temperature and stratification levels.

WHERE WE HELP

- » Reduce installation cost by eliminating control wiring
- » Control fans individually or in groups over 2.4Ghz WiFi
- » Provide fan control from anywhere in the world on your portable device or laptop

FEATURES

- » Interface is web-based (Chrome/Firefox), iOS, or Android
- » Monitor temperature and humidity at fan and floor level
- » Utilise temperature information to provide cooling air flow
- » Monitor Delta-T (stratification level)
- » Monitor fans via the integrated tachometer
- » Alerts for run time and/or stratification
- » Upgrade firmware via Over The Air (OTA) encrypted firmware updates

Housing: PC/ABS, Off white (cool gray 2c)

Mounting: Factory installed at time of ordering.

Power Consumption

Idle: 16mA
TX/RX: 200mA

Wi-Fi Characteristics

802.11b/g/n 2.4 GHz
TX Power 18 dBm @ 1DSSS
RX Sensitivity -96 dBm @ 1 DSSS
Range 100 meters

Sensors & Accuracy

Temperature Sensor +/- 0.5°C
Humidity Sensor +/- 1% RH
Tachometer +/- 3%

Interface

Web-based (Chrome/Firefox), iOS, or Android (Mobile apps available in App Store and Google Play Store)

Requirements

2.4 GHz Wi-Fi network
Phone or tablet with iOS 8 or later, or Android 4 or later required for setup
Browser for accessing the web dashboard to control devices (PC or MAC)
A free PearLink Account

Operating Conditions

Temperature 0 to 48.8°C
Humidity Up to 90% RH
Altitude Up to 3,300 mts

Ordering

The PearLink control is a factory installed option. Please refer to the individual model data sheets for configuring your fan.

Warranty

1 years parts and workmanship.



AIRIUS FAN SYSTEM



AIRIUS CONTROLS SERVER

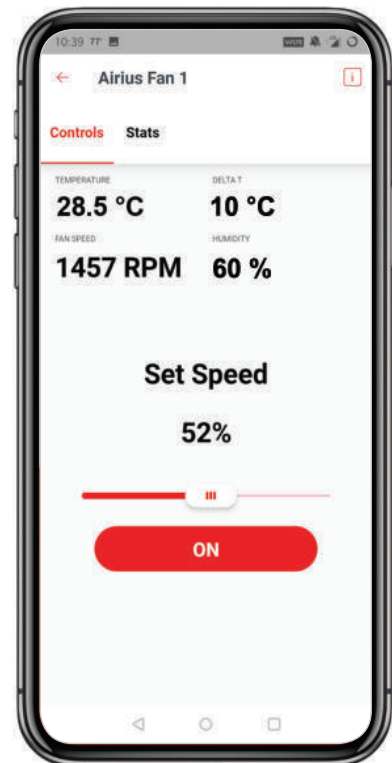

PHONE OR TABLET

PEARLINK

Quick Setup Guide

ACCOUNT CREATION

Once you have purchased your Airius Wi-Fi fans, simply download the free 'Pearlink Wireless Fan Control' app from the app store or visit <https://controls.airiusfans.com/dashboard/login> and create an account using your email address to log in.

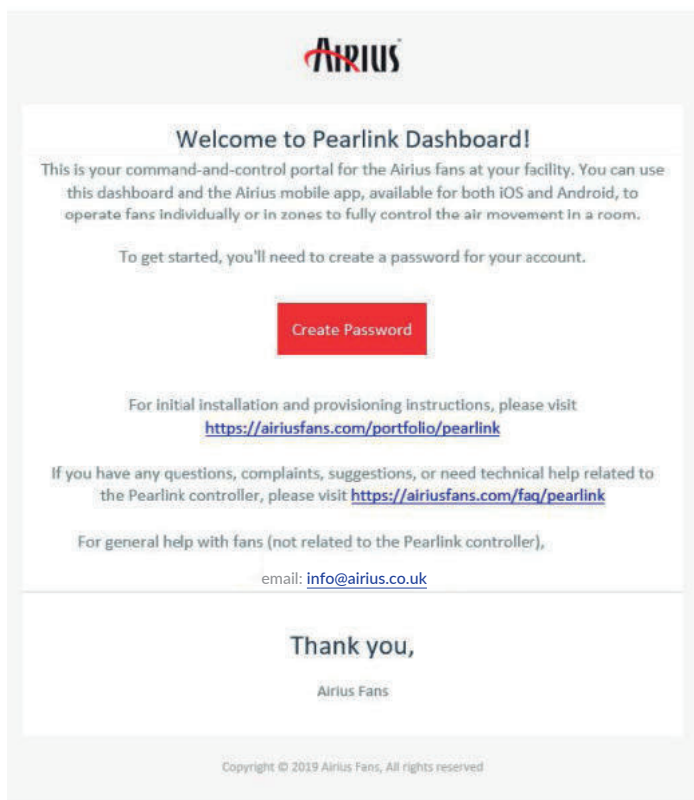

This is your command-and-control portal for the Airius fans at your facility. You can use the web based dashboard or the the Airius PearLink mobile app, available for both iOS and Android, to operate fans to fully control the air movement in a room.

What you will need before moving on:

- > Your Wi-Fi network name and associated password
- > Android, iOS device, laptop or desktop computer (for provisioning)
- > Height of each fan A.F.F. (above finished floor)

To begin, please download and install the Airius 'PearLink Wireless Fan Control' app, which can be found on the Google Play or Apple Stores, or visit:

- > <https://controls.airiusfans.com/dashboard/login>.

PROVISIONING DEVICES

The Airius fan system should be installed, powered and within Wi-Fi range along with the Android/iOS device used to provision the fans. The floor sensor should be located within the same space, connected to power using the small transformer supplied and installed 1.5-1.8 mts A.F.F. Preferably next to your existing thermostat.

Open the Airius App and enter your email address and password to log in. You are now ready to provision your devices.

Note: the screen shots are from an Android device and might vary slightly for iOS devices.

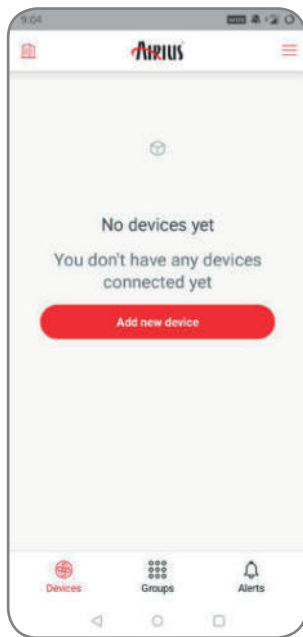

Press the "Add new device" button:

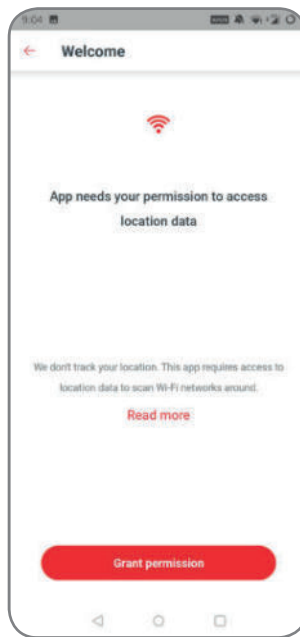

Grant Wi-Fi Permission

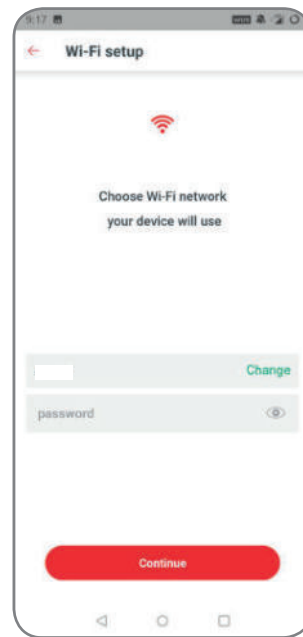

Enter your Wi-Fi credentials

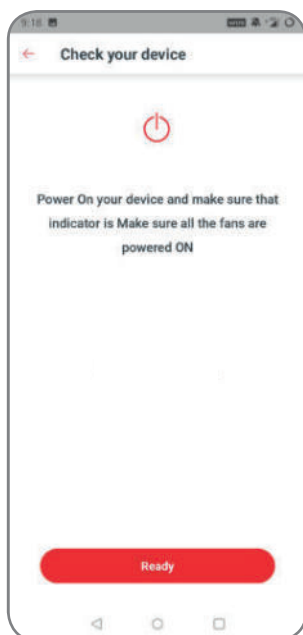

Press the "Ready" button:



Choose your device. Provision all floor sensors before any fans.

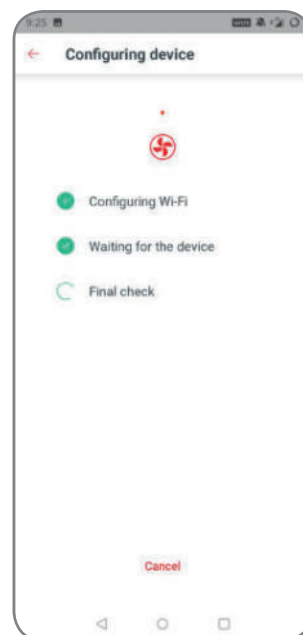

App will provision device

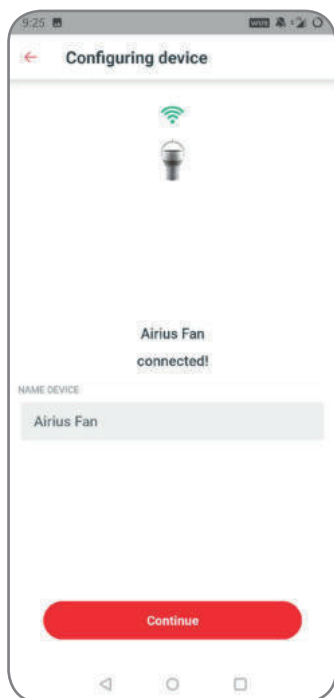

Name the device

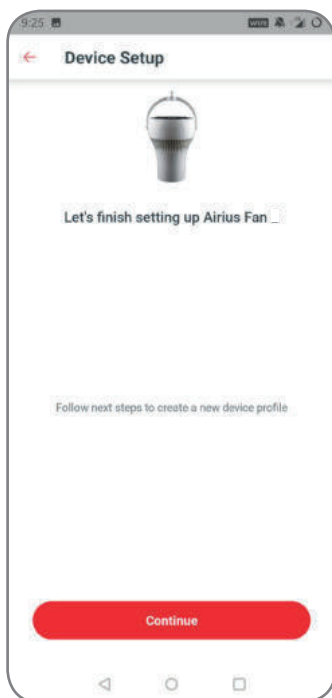

Continue

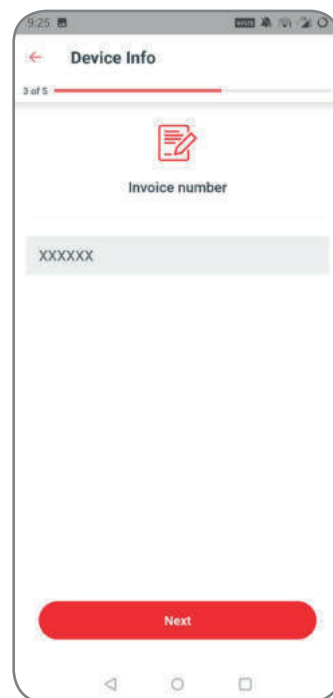

Enter the associated invoice number

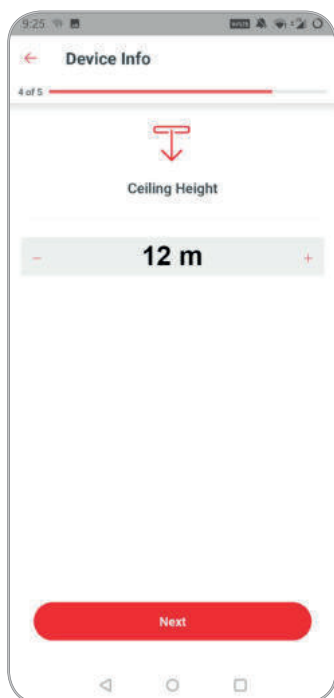

Enter the ceiling height where the fan is installed

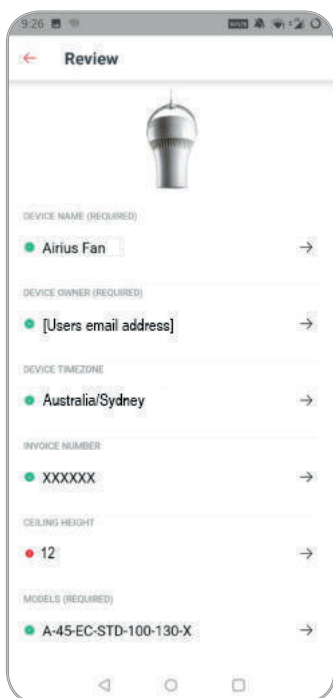

Review the information and select the correct fan model from the drop down menu

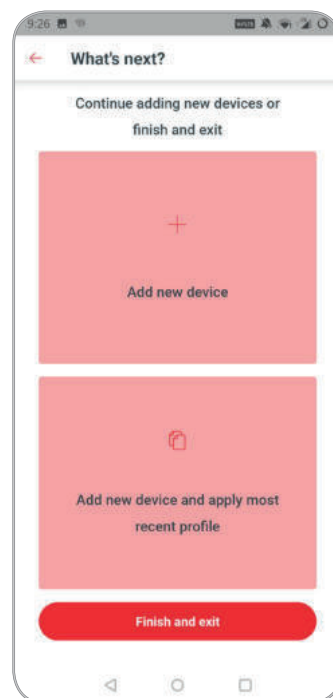

Select, "Add new device and apply most recent profile" > Follow the same steps for each device

DEVICE CONTROL

The PearLink app allows for individual and group fan control. PearLink will monitor the air temperature at the fan and at the floor to provide a delta temperature. The humidity and air temperature will be logged and viewed within the app. This data can be exported as a csv file.

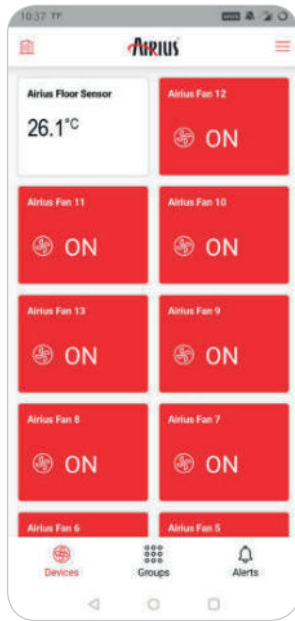

The device screen shows your device list. Press and hold will turn a device on/off. Pressing once will pull up the following screen for the specific device.

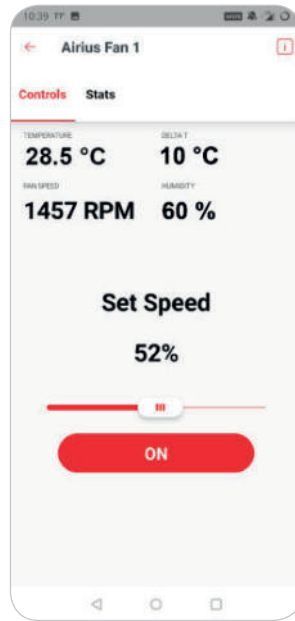

Individual device view. You can adjust individual fan speed, see the air temp/humidity at the fan and the rpm. Delta T = Fan temp - Floor sensor temp.

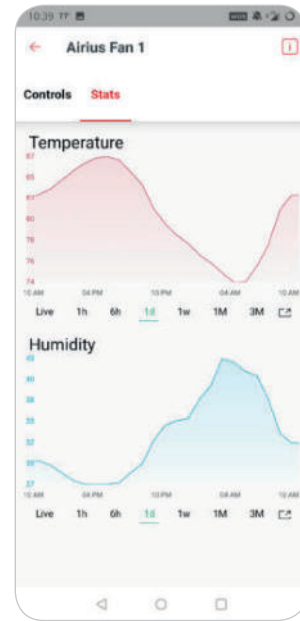

The stats tab shows temperature and humidity at the device over various periods of time. You can export this information as a csv from this view.

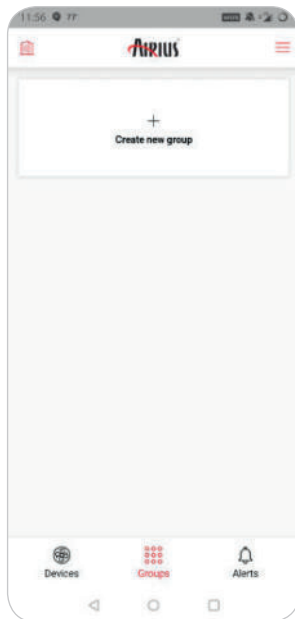

The group screen shows your fan/sensor groupings. Create a new group by pressing on the "Create new group" button.

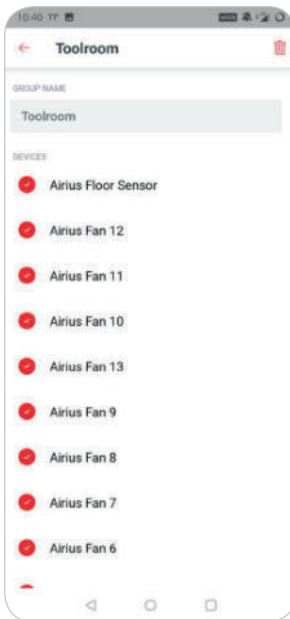

Name your group and select the devices you would like to add to this group. You now have the ability to control the fan speed of all devices within that group as well as on/off.

NETWORK MIGRATION

If you need to change your Wi-Fi network name or password for any reason, you must follow this process. If the name or password is changed before this step, the devices cannot be connected to. The only way to recover them is to revert back to the old network name and password. The following process will need to be repeated for all devices.

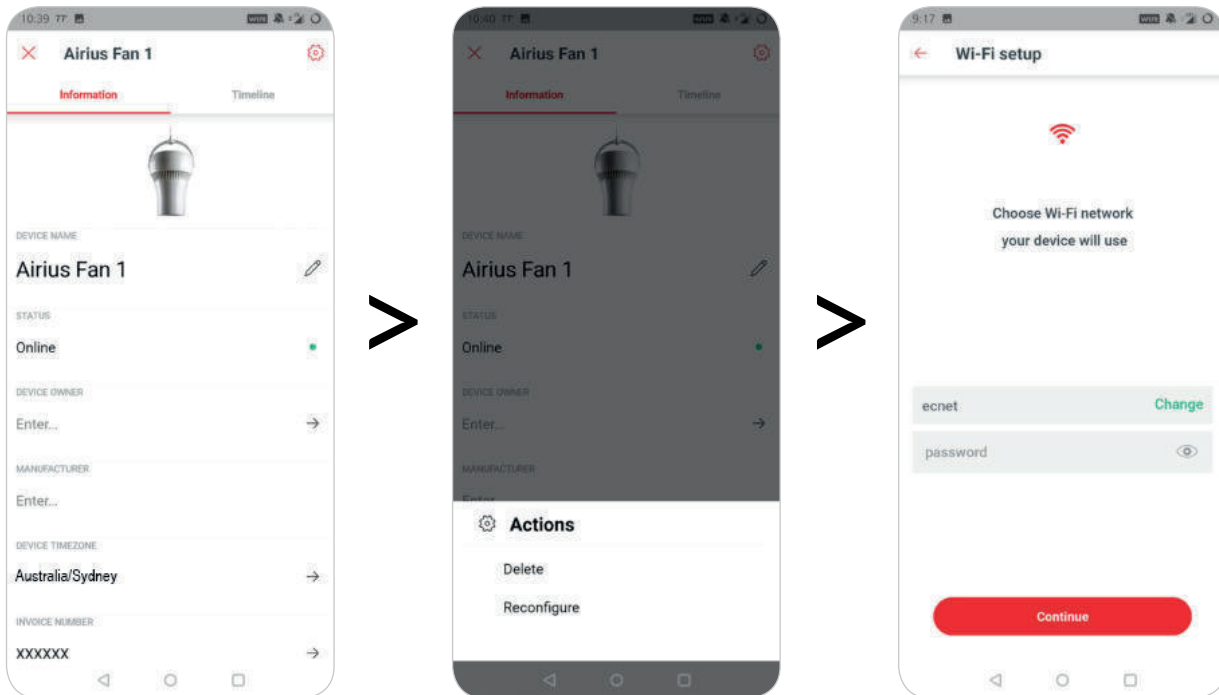

Under the individual device view, select the “i” icon then the gear icon in the upper right portion of the app.

Under “Actions” select “Reconfigure”

At this screen, you can enter the network name and/or password changes.

BMS CONTROL WIRING

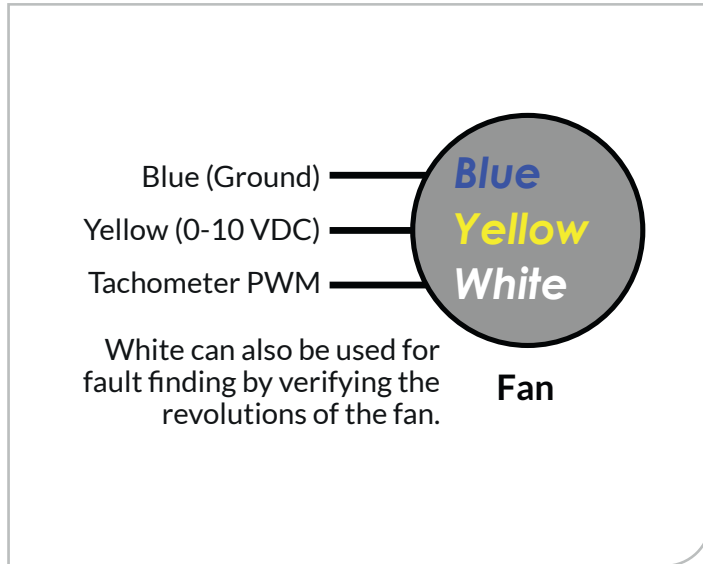

GENERAL NOTES

0-10 V signal allows infinitely variable open loop speed control

Connecting the red and yellow leads will allow EC fans to operate at full speed

A single controller can be used to control multiple fans with the same speed setting

The BMS generates this voltage to send to the signal (yellow)

Yellow is labelled as 0-10VDC because that is the acceptable range of voltages that the fan will accept

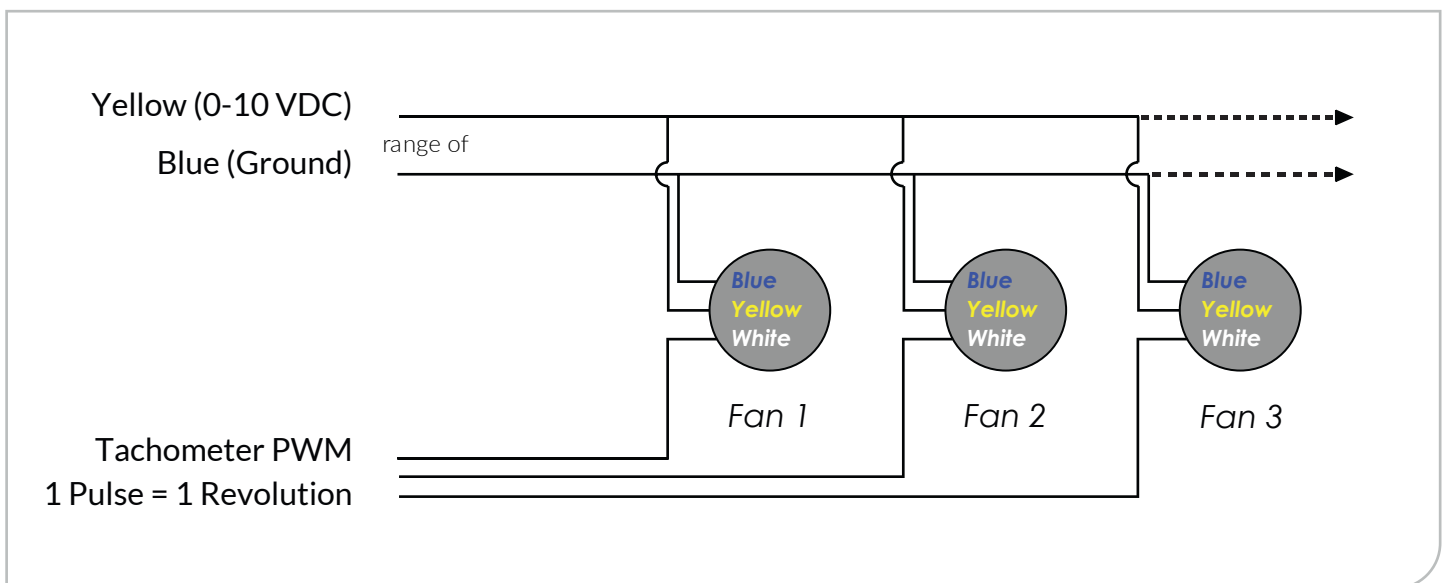

(0-10V) POTENTIOMETER EC FAN SPEED CONTROLLER



Technical Data

Voltage: 230VAC – 50/60Hz
 Output: 0-10 Vdc > 1 kOhm (max 8 mA)

1 X EC CONTROLLER REQUIRED PER CIRCUIT.

PLEASE CONTACT AIRIUS FOR RECOMMENDED QUANTITY OF FANS PER CONTROLLER FOR YOUR UNIQUE APPLICATION.

WARRANTY

Two years from delivery date against defects in manufacturing. Any modifications or alterations to the product relieve the manufacturer of all responsibility.

The manufacturer bears no responsibility for any misprints or mistakes in this data, and modifications or improvements to the product can be made at any time after date of publication.

DIMENSIONS

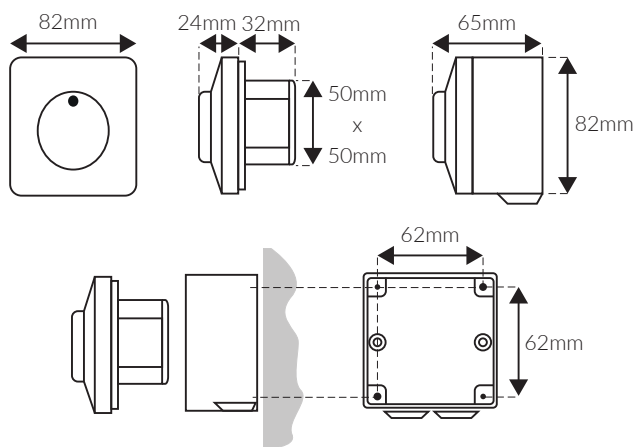

COMPONENTS

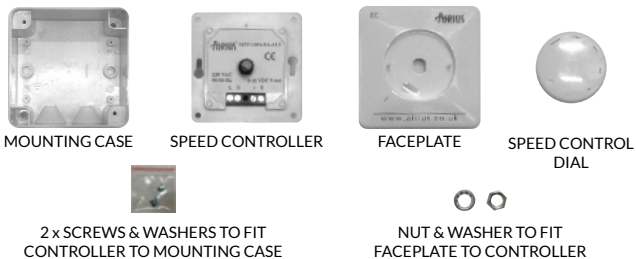

WIRING

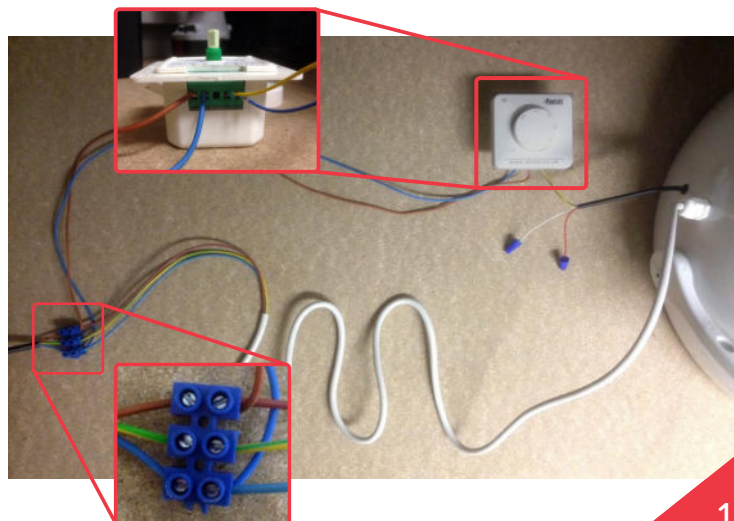
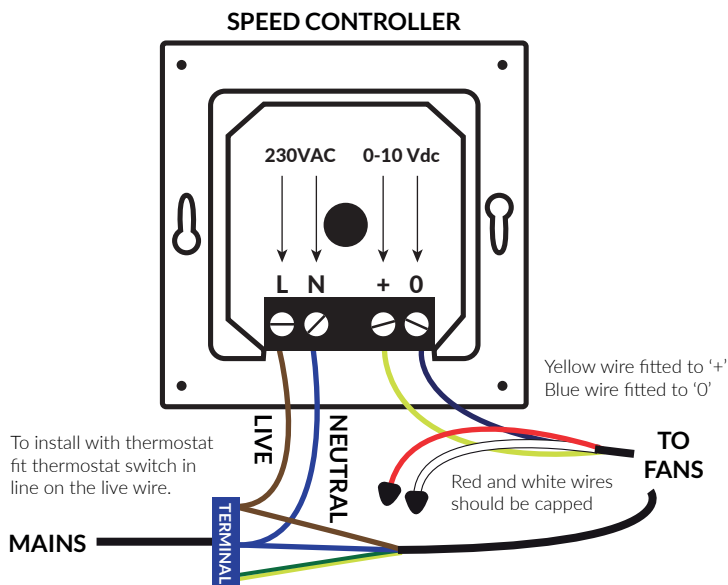

INSET MOUNTING (IP44)

Break mains voltage. Connect according to diagram. Mount the inner case to the wall with the connections pointing down. Mount cover with nut to the wall. Push knob in place at off position.

SURFACE MOUNTING (IP54)

Break mains voltage. Mount surface mounting case to the wall together with included grommets. Connect according to diagram. Mount inner case in surface mounting case with included screws. Mount cover with nut to surface mounting case. Push knob in place at off position. When needed a 5mm hole for condensation water is to be drilled at the bottom of the surface mounting case.

IN CASE OF FAULTY OPERATION

Please check: right voltage is applied, all connections are correct, the machine to be regulated is functioning.

TRANSPORT AND STOCK KEEPING

Avoid shocks. Stock in original packaging. Avoid extreme conditions.

MAINTENANCE

In normal conditions the controllers are maintenance-free. If soiled clean with dry or dampish cloth. In case of heavy pollution clean with a non-aggressive product. In these circumstances the controller should be disconnected from the mains. Pay attention that no fluids enter the controller. Only reconnect the controller to the mains when it is completely dry.

All works may only be carried out by skilled personnel following the local regulations and AFTER the controller is completely separated from the mains.

CAUTION

Electrical installations should only be carried out by qualified personnel only. Follow safety measures to avoid electric shock.

According to the low voltage directive: 2006/95/EC/
The EMC directive: 2004/108/EC





Arius Europe, Middle East & Asia

Arius Europe Ltd
Holwell Farm, Cranborne
Dorset
BH21 5QP, UK
Tel - +44 (0) 1202 554200
Fax - +44 (0) 1202 554396
Email - info@airius.co.uk
Web - www.airius.co.uk

Arius Americas

811 South Sherman Street
Longmont
Colorado
80501 USA
Tel - (00) 1 888 247 7327
Email - Info@airiusfans.com
Web - www.airiusfans.com

Arius Oceania & S.E. Asia

P.O. Box 1812
Byron Bay
NSW
2481 AUSTRALIA
Tel - +61 (2) 6608 2736
Email - info@airius.com.au
Web - www.airius.com.au

USA and foreign Patents granted to AIRIUS LLC, USA, further patents pending. AIRIUS & AIRIUS SYSTEMS is the copyright property of AIRIUS LLC, USA. All material issued by, or emanating from, Airius Europe Ltd is the Copyright property of Airius Europe Ltd, UK.

